

Sauna Craft CTT Heater Installation Manual

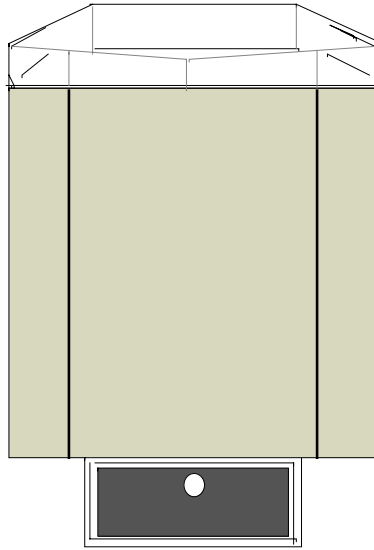

NOTES FOR ALL HEATERS

Heater Guard Fence:

A non-metallic guard (not included) shall be provided and installed as follows:

- a) 4" from CW Series heaters
- b) 6" from FM Series heaters

Sauna Rocks (included):

- 1) Wash the rocks before placing on heater.
- 2) **Do not pack rocks too tightly into rock tray. There should be pockets of air. Stack rocks loosely in a "pyramid" like pile. Packing rocks too tightly will trap heat and cause the hi-limit to trip.**
- 3) These units must not be operated without the igneous rocks in place

Water:

Do not soak the heater with water. Water should be used in moderation Sprinkling with a ladle is recommended.

Manual Reset High Limit Control:

- 1) This safety device must not be by-passed in the wiring of this sauna heater.
- 2) Should the high temperature limit control trip frequently, a qualified serviceman should be contacted.

- A licensed electrical contractor should do all electrical work.
- Do NOT use a G.F.I breaker.
- All cables used in the installation of these units must be rated for 300 VAC.
- All cables supplied and connected to these units must be rated for 90° Celsius.

FIRST TIME USE

When using the sauna for the first time it is normal to have a little smoke. The elements are burning off oil residue left by the manufacturing process. Turn the sauna on for ½ hour, leave the door open and do not go inside.

SAUNA CRAFT CTT HEATER w/ BUILT IN CONTROL

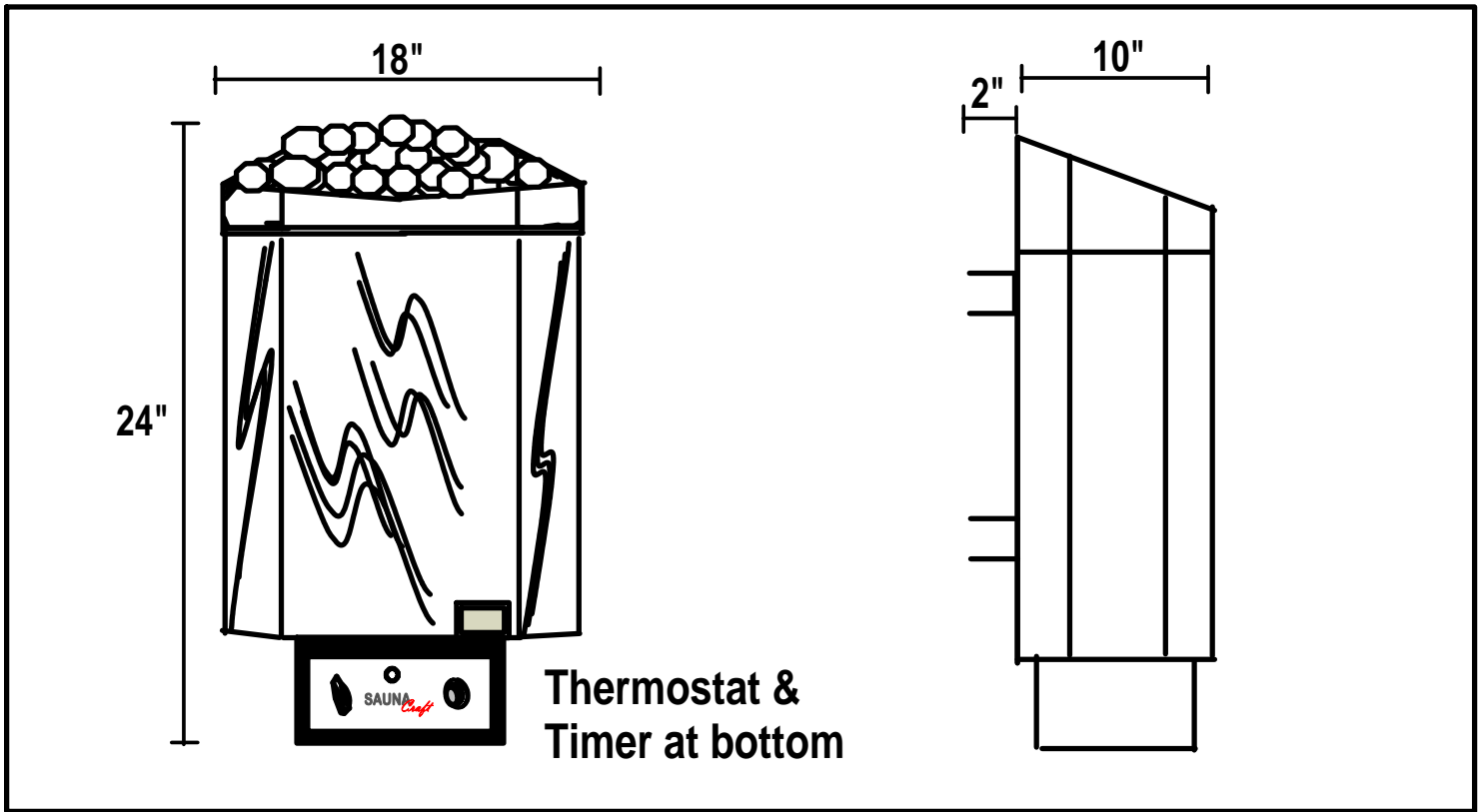

CEILING

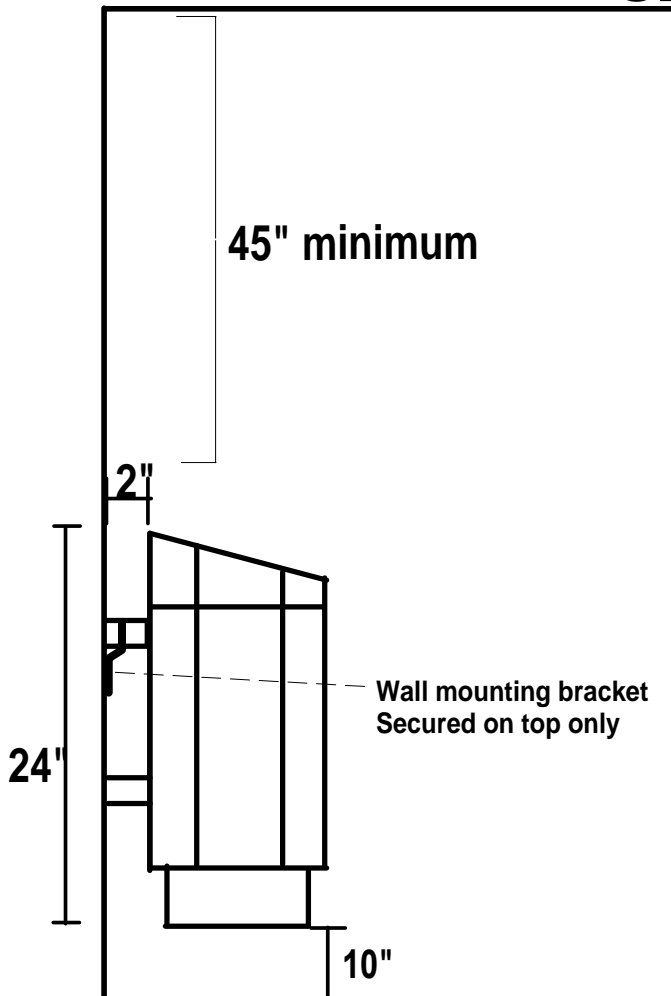

ROCKS

Extra rocks are supplied. Use 1/2 to 2/3. Keep the rest for extra. Do not "choke" the heater. Ideally, leave one of side rock compartment open. Choking the heater will result in nuisance hi-limit tripping at low temperatures.

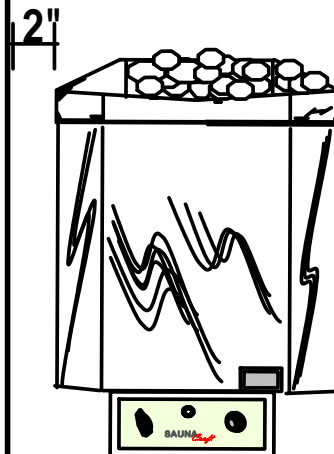

CTT SERIES HEATER WIRING DIAGRAM

CTT heaters have controls built into the front bottom of heater

4 - 6 KW / 240 VOLT/ 1 PHASE

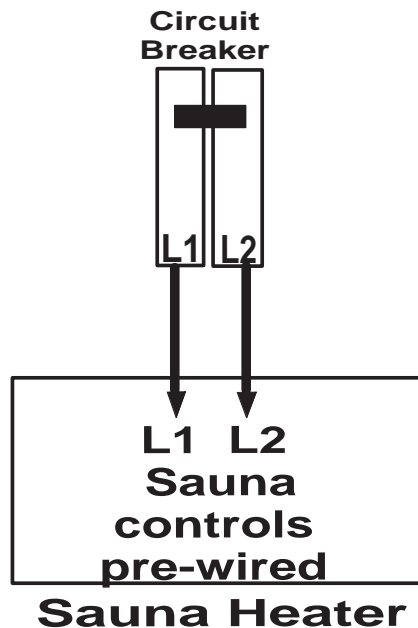

Control rated to 30 amps.
No magnetic contactor
required for heaters
up 6 kw (240 volt)

<u>Watts</u>	<u>Volts</u>	<u>Phase</u>	<u>Wire Size</u>	<u>Circuit Breaker</u>
4000	240	1	10	30
5000	240	1	10	30
6000	240	1	8	40

**DO NOT USE G.F.I.
BREAKER**

7.5 - 9 KW / 1 & 3 PHASE

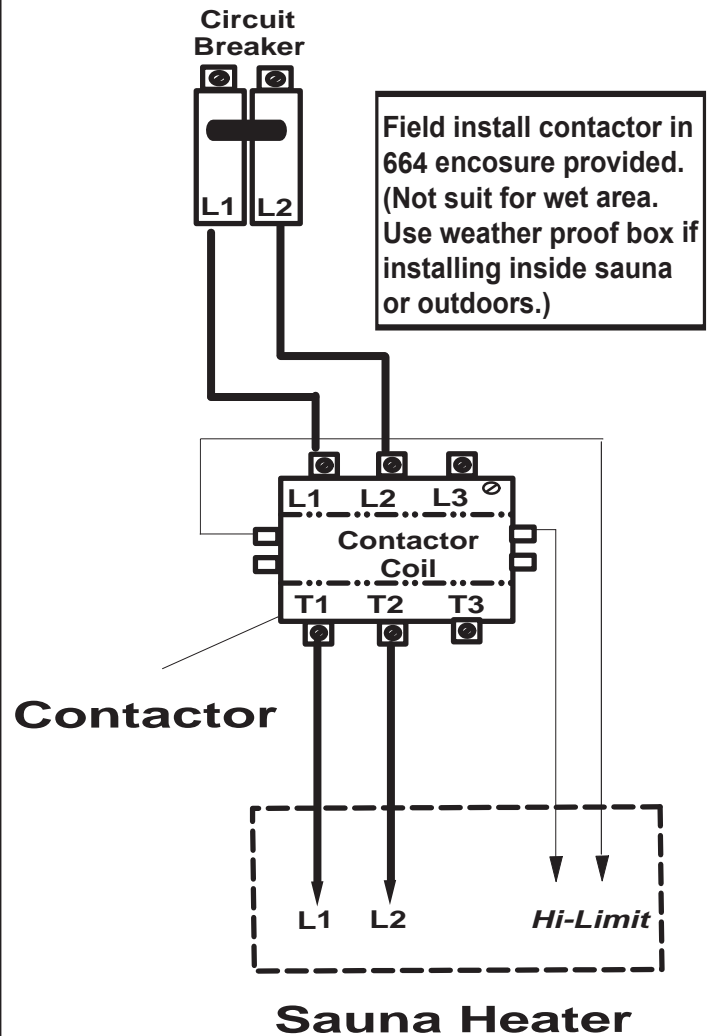

<u>Watts</u>	<u>Volts</u>	<u>Phase</u>	<u>Wire Size</u>	<u>Circuit Breaker</u>
7500	240	1	8	40
9000	240	1	8	50

The SAUNA CRAFT "CTT" series have the controls built right in. The mounting and positioning procedure for the "CTT" series heater is identical to that of the "CW" series. Please refer to standard Heater Instruction Manual.

SAUNA ROCK PLACEMENT-SC

SAUNA CRAFT HEATERS

FILLING THE ROCK COMPARTMENT (FIGURES 10-14)

The rocks should not be stuffed into every nook and cranny. This will "choke" the heater, trapping the heat inside and will result in nuisance tripping of the heater's built-in hi-limit. Placing the rocks properly improves heater operation and speeds up the heat up time.

Extra rocks are supplied. Depending on the heater model, you will use about 1/2 to 2/3. Keep the rest for extra.

The rocks should be filled as indicated below:

CWS, CWM (Figure 10): *Fill center and one side chamber. Leave the other side chamber open.*

CW-XR (Figure 12): *Fill center and one side. Leave the other side open. .*

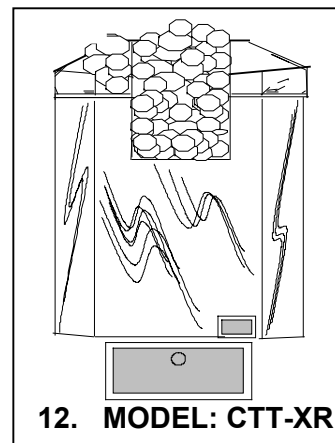
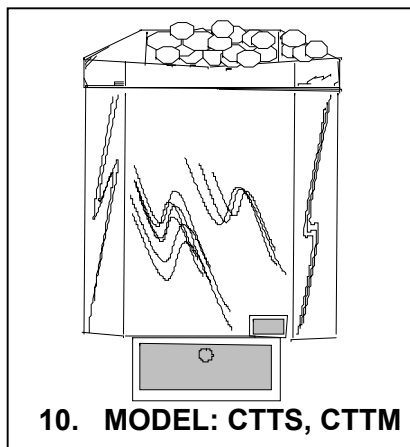

SAUNA TROUBLE SHOOTING

<u>Problem</u>	<u>Probable Cause</u>	<u>Remedy</u>
Note: Except where noted otherwise, reference to control refers to TPT3 mechanical control		
Heater will not start	Control wired incorrectly	Check wiring diagram carefully to ensure control circuit is wired correctly
	High temperature control has tripped	Using pencil or other non-conductive material, carefully push in "reset" button at front bottom of heater
	Thermostat off or set below room temperature	Turn thermostat clockwise. Saunas are generally set to between
	Timer off	Turn timer clockwise
	No Power	Turn on breaker. If on, it may be faulty or installed incorrectly. Call for service.
	Faulty magnetic contactor (applies only to heaters 7.5 kw & larger)	Call for assistance. Call service person.
Sauna not hot enough	Temperature not set high enough	Set thermostat higher-
	Thermostat sensor not positioned properly	
	Thermostat miscalibrated	Recalibrate or replace
Sauna on, but no real heat. Elements are not glowing red.	Sauna has been wired at 120 volt. (Note:two 120 volt lines does not make 240 volt.	Call qualified service person. Using meter, confirm there is 240 across line 1 and line 2.
One or more elements not glowing red	One or more elements burned out	Replace element
Pilot light on. No Heat	High Limit tripped	Reset. (See above)
	High Limit defective	Replace high limit
High Limit trips frequently	Too many rocks or rocks packed too tightly, trapping heat inside. (very common)	Leave one side of rock tray free of rocks. Rocks should be stacked so that air can pass through.
	Thermostat broken or miscalibrated	Recalibrate or replace
Sauna too hot	(Public) Sauna being tampered with by users; i.e splashing water or placing wet towel on thermostat sensor bulb	Close sauna to public use. Run heater for 2-3 three hours. If sauna does not trip, this suggests the problem is user tampering.
	High Limit defective	Replace high limit
Sauna too hot	Sensor not properly positioned	Reposition sensor or lower thermostat setting to compensate.
	Thermostat broken or miscalibrated	Recalibrate or replace
Breaker trips frequently	G.F.C.I. breaker was used	Replace with standard breaker
	Breaker too small for heater installed	Replace with properly rated breaker
	Short circuit or ground in wiring	Call service person.

SAUNA CRAFT LIMITED WARRANTY **“CTT-S”, “CTT-M”, & CTT-XR SERIES HEATERS**

Model No. _____ Serial No. _____

Date of Purchase _____ Date of Installation _____

Sauna craft hereby warrants that the following Sauna Craft sauna heater is free from all defects in workmanship and materials for a period of

CW-S & CW-M Series: - Five (5) years from the DATE OF PURCHASE.

[Commercial use carries only a one (1) year warranty, excluding elements.]

CW-XR Series: – Residential use, LIFETIME WARRANTY from the DATE OF PURCHASE.

[CW-XR commercial use, three (3) year warranty, including elements.]

This warranty does not extend to damage caused by improper or negligent installation or use, or for repairs by any person other than an authorized Sauna Craft dealer, and shall be limited to the repair or replacement of defective parts by Sauna Craft, after the unit has been disconnected and returned to Sauna Craft. Said repairs shall be without charge if within six (6) months of the date of purchase of the **DATE OF PURCHASE**. After the expiration of the first six (6) months for the duration of the limited warranty period, there shall be a reasonable charge for labor incurred in connection with the repair or replacement required.

For CTT-S & CTT-M sauna heaters used residentially, defective parts are warranted from the date of purchase as follows: First year - 100%, second - 80%, third year - 60, fourth year – 40%, fifth year – 20%.

For CTT-S & CTT-M sauna heater used commercially, defective parts are warranted 100% from the date of purchase for a period of one (1) year. Elements are warranted 100% for thirty days (30).

For CTT-XR sauna heaters used residentially, defective parts are warranted from the date of purchase as follows: Lifetime

For CTT-XR sauna heaters used commercially (208 volt, 3 phase), defective parts are warranted 100% from the date of purchase as follows:

Three years including elements.

Excludes hi-limit device.

Note: Commercial 240 volt Heaters carry extended warranty only if purchased as commercial units at commercial pricing.

Freight: The customer is required to ship freight prepaid to Sauna Craft and Sauna Craft will then ship freight prepaid back to the customer. The unit should not be shipped back without prior approval of Sauna Craft.

A COPY OF THIS WARRANTY AND THE BILL OF SALE MUST ACCOMPANY THE RETURNED DEFECTIVE PART.

This is not a service contract and this warranty does not include regular maintenance, cleaning or periodic check-ups, which are the sole and exclusive responsibility of the purchaser and are required as a condition of keeping this limited warranty in full force and effect.

This warranty is not transferable and shall extend only to the original purchaser.

This warranty is void if any of the following should occur:

1. If the unit is used for anything other than a sauna installation or application.
2. If the serial number has been altered or removed.
3. If the unit is modified in any manner, which Sauna Craft concludes, after inspection, affects the reliability of the unit.
4. If the unit has been repaired or serviced or repaired by anyone not specifically authorized by Sauna Craft
5. If the unit is damaged because it is not operated or installed in accordance with supplied instructions.

The sole responsibility of Sauna Craft under this warranty shall be limited to the repair of the unit or replacement thereof, including parts, in the sole discretion of Sauna Craft. The consumer's sole remedy shall be such repair or replacements as expressly provided herein, and under no circumstances shall Sauna Craft be liable for any loss or damage, be it direct or consequential, arising out of the use or inability to use this product.

THE FOREGOING IS IN LIEU OF ALL OTHER WARRANTIES AND SPECIFICALLY EXCLUDES EXPRESS AND IMPLIED WARRANTIES OF MERCHANTABILITY OR OF FITNESS FOR PARTICULAR USE OF PURPOSE. THERE ARE NO WARRANTIES WHICH EXTEND BEYOND THE DESCRIPTION ON THE FACE HEREOF, AND NEITHER SAUNA CRAFT NOR ITS DEALERS ASSUMES OR AUTHORIZES ANY PERSON TO ASSUME FOR ANY OF THEM ANY OTHER OBLIGATION OR LIABILITY IN CONNECTION WITH SAID EQUIPMENT.

No warranty, whether express or implied, is given or made with respect to any accessory supplied by anyone other than Sauna Craft. Purchaser acknowledges that no other representations were made to him or relied on by him with respect to the quality and function of the heater

HOW TO TAKE A SAUNA

1. Start with a brief shower using warm water and soap. Rinse thoroughly. Do not towel dry.
- 2 Enter the pre-heated sauna - 9 or 10 on numbered dial (80°-90° C on temp dial). Take a towel in with you to sit on.

Relax and allow your body to perspire freely in the soft dry heat. Do not throw water on the rocks in this first session. Do not expect to begin and finish your sauna in a few minutes. Even in the extreme heat of a sauna, it takes time for your body temperature to rise and for you to begin to perspire freely.

- 3 Stay inside the sauna only as long as it feels pleasant. Go out now and then to cool off and freshen up with a quick cool shower. How long you stay in the sauna is up to you. It depends on your comfort level. It is not an endurance test. People often start at 5-10 minute intervals and work up to longer periods.

Young children love saunas. Let them splash about in a tub of water on the floor or the lower benches where it is somewhat cooler. But remember to keep an eye on them at all times

- 4 Re-enter the sauna. Sprinkle water on the hot rocks to bring up a little steam and increase the humidity. This will increase the feeling of heat and assist the perspiration process. If you like add a few drops of scented essence such as eucalyptus into the water you splash on the rocks. It will disperse throughout the sauna.
- 5 Take a cold shower. Repeat the sauna/cold water cycle as often as you desire.
- 6 Dry yourself completely. Then sit or lie down, letting your body relax.
- 7 Relax, treat yourself to a cold drink and enjoy a sensation of true well-being. Don't get dressed until your body has cooled down and your pores have closed. Never get dressed right after your sauna. This will only cause you to perspire

NOTE: When used for the first time, you will notice smoke coming off the heater elements. This is normal. Leave the door open and allow the sauna to run about 30 minutes.

Technical Support

Before calling, please review the trouble-shooting guide in this manual. When calling please have the following information:

Heater Model # _____

Contact Model # _____
(Applies only to heaters 7.5 kw or larger)

Contact Information

Sauna Craft
115 Bowes Rd, Unit 2
Concord, ON
L4K 1H7
Phone: 905-738-9443
Fax: 905-738-2486